

2D REFERENCE SIZE(UNIT:mm)

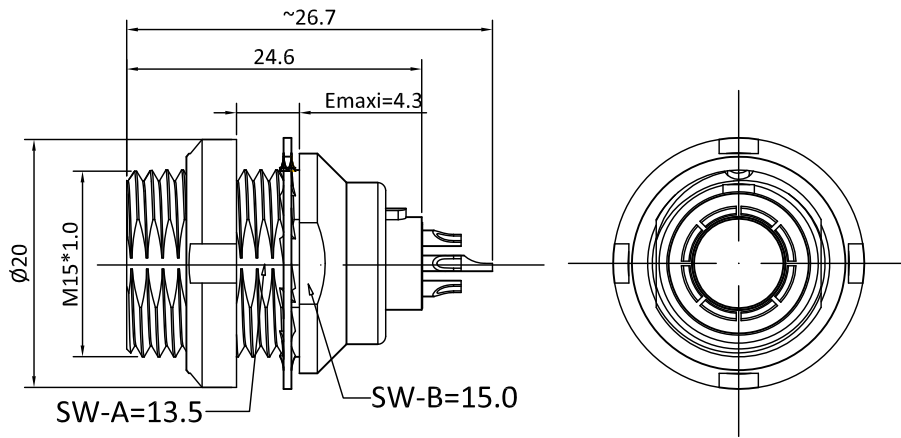

- Housing Material: Brass pearled chrome
- Insulator Material: PPS
- Contact Material: Copper alloy
- Mating cycle: 5000 times(IEC 60512 test 9a)
- IP Rating: IP50。(IEC 60529)
- Humidity (max): <=95%[at 60°C]
- Temp (min/max): -55°C~+125°C(GB/T2423.3)
- Vibration: 10-2000Hz, 15g(IEC 60512-4 test 6d)
- Shock Resistance: 100g, 6ms(IEC 60512-4 test 6c)
- Salt Spray Corrosion: >96h(IEC 60512-6 test 11f)

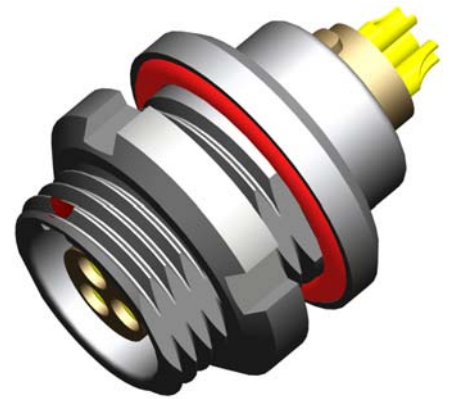

Images is for illustrative purpose only

PART NUMBERING SYSTEM:

FIXED SOCKET

SEG · 2B326 · CP*

MODEL

KEY:
G=0°; A=30°;
B=60°; C=90°; ...

SERIES





CONTACTS:3=MULTICORE;
26=26PINS (2~26PINS OPTIONAL)

HOUSING:
C=BRASS PEARLED CHROME;
K=BRASS PLATED BLACK CHROME;
T=ALUMINIUM ALLOY PLATED NICKEL

INSULATOR:
P=PPS;K=PEEK;

CONTACTS TYPE:
A=MALE SOLDER ;L:FEMALE SOLDER;
D=PCB-MALE ;N=PCB-FEMALE;V=PCB
FEMALE ELBOW

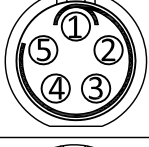
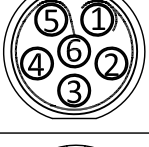
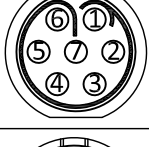
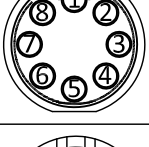
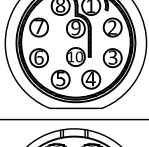
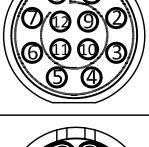
*=Customers can choose the model according to their own needs

P/N	CORE	TYPE	PIN DIA (mm)	WORK VOLTAGE (KV rms)		RATED CURRENT (A)	CONTACT R ESISTANCE (mΩ)	CABLE (AWG)	
				CONTACTS- CONTACTS	CONTACTS- SHELL			min.	max.
SEG.2B302.CP*	2		2.0	2.10	1.75	25	5	18	12
SEG.2B303.CP*	3		1.6	2.40	1.85	17	5	22	14
SEG.2B304.CP*	4		1.3	1.85	1.85	15	6	26	18
SEG.2B305.CP*	5		1.3	1.75	1.6	14	6	26	18
SEG.2B306.CP*	6		1.3	1.35	1.45	12	7.5	26	18
SEG.2B307.CP*	7		1.3	1.75	1.6	11	7.5	26	18
SEG.2B308.CP*	8		0.9	1.5	1.25	10	7.5	32	20
SEG.2B310.CP*	10		0.9	1.45	1.3	8	10	32	20
SEG.2B312.CP*	12		0.7	1.25	1.35	7	10	32	22
SEG.2B314.CP*	14		0.7	1.15	1.35	6.5	10	32	22

*=Customers can choose the model according to their own needs

P/N	CORE	TYPE	PIN DIA (mm)	WORK VOLTAGE (KV rms)		RATED CURRENT (A)	CONTACT RESISTANCE (mΩ)	CABLE (AWG)	
				CONTACTS-CONTACTS	CONTACTS-SHELL			min.	max.
SEG.2B316.CP*	16		0.7	0.95	1.25	6	10	32	22
SEG.2B318.CP*	18		0.7	0.85	1.2	5.5	10	32	22
SEG.2B319.CP*	19		0.7	0.95	1.25	5	10	32	22
SEG.2B326.CP*	26		0.5	0.95	1.30	2	10	-	-

*=Customers can choose the model according to their own needs

PCB OPEN SIZE(STRAIGHT)	PCB OPEN SIZE(ELBOW)	PCB OPEN SIZE(STRAIGHT)	PCB OPEN SIZE(ELBOW)
	02		03
	04		05

NOTE: SOCKET WITH ELBOW(90°)CONTACT FOR PRINTED CIRCUIT, RATED CURRENT:6A

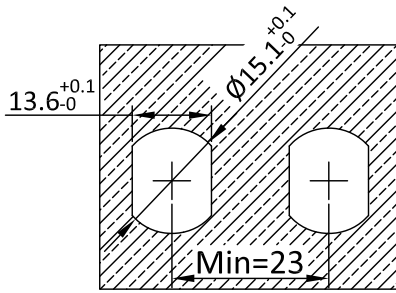

SERIES PANEL HOLES SIZE

PCB OPEN SIZE(STRAIGHT)

PCB OPEN SIZE(ELBOW)

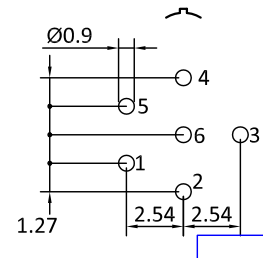
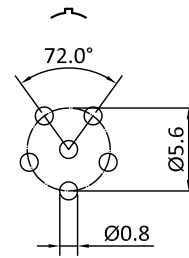

PCB OPEN SIZE(STRAIGHT)

PCB OPEN SIZE(ELBOW)

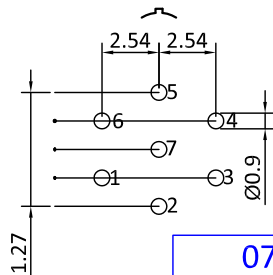
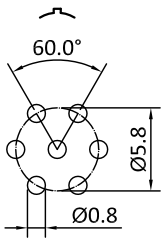

07

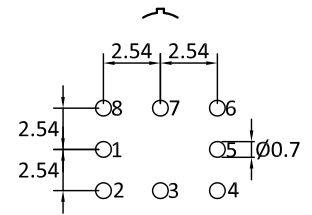
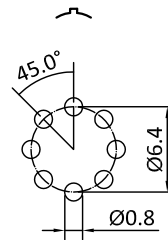

08

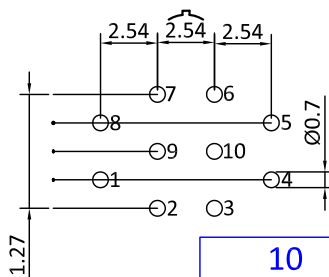
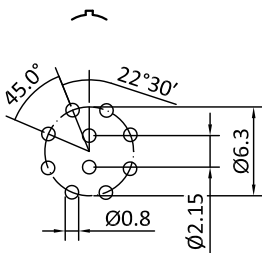

10

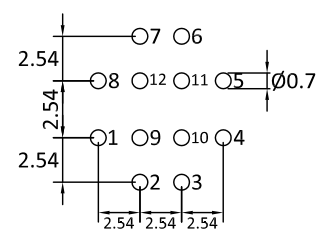
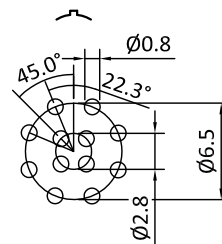

12

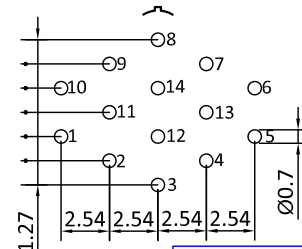
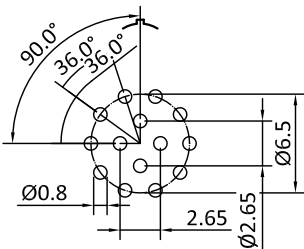

14

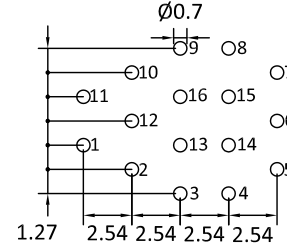
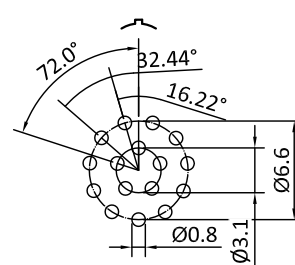

16

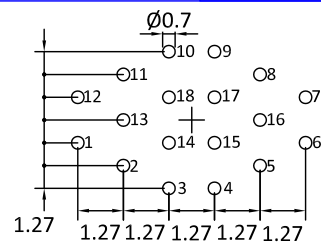
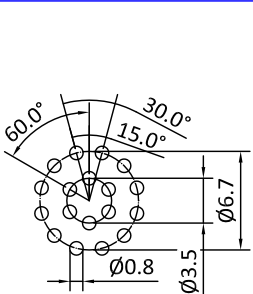

18

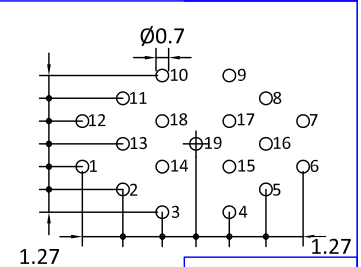
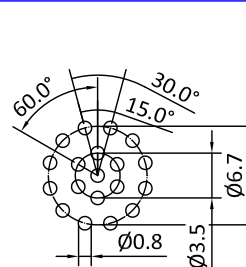

19

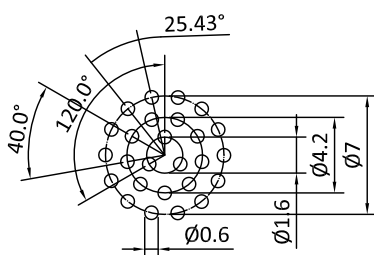

26